

BLUE BATTERY

BL 12-40A

KESİNTİSİZ ENERJİ ÇÖZÜMLERİ



► Specifications

Nominal Voltage		12V
Rated capacity (20 hour rate)		40Ah
Dimensions	Length	196± 1.5mm (7.72inch)
	Width	166± 1mm(6.54inch)
	Height	173± 1mm(6.81inch)
	Total Height	173± 1mm(6.81inch)
Approx. Weight		11.9kg(26.24lbs)± 4%

► Outer Dimensions (mm)

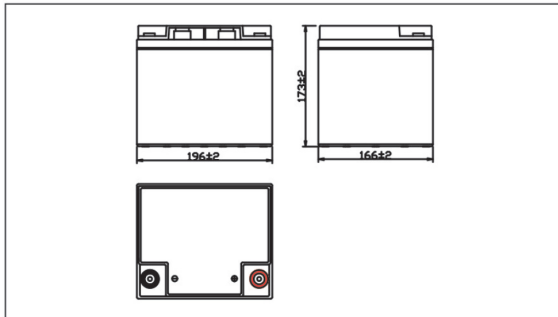

► Terminal Type (mm)

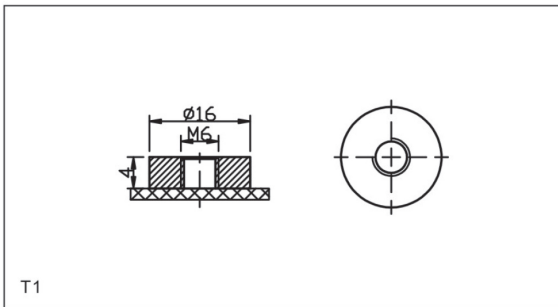

T1

► Characteristics

Capacity (25°C)	20HR(10.5V)	40Ah
	10HR(10.5V)	37Ah
	1HR(9.60V)	22.8Ah
Terminal type		T1
Internal resistance (Fully charged, 25°C)		Approx. 14m Ω
Capacity affected by temperature (20HR)	40°C	102%
	25°C	100%
	0°C	85%
	-15°C	65%
Self-discharge (25°C)	3 months	Remaining Capacity:91%
	6 months	Remaining Capacity:82%
	12 months	Remaining Capacity:65%
Nominal operating temperature		25°C± 3°C(77°F± 5°F)
Operating temperature range	Discharge	-15°C~50°C(5°F~122°F)
	Charge	-10°C~50°C(14°F~122°F)
	Storage	-20°C~50°C(-4°F~122°F)
Float charging voltage(25°C)		13.50 to 13.80V Temperature compensation: -18mV/°C
Cyclic charging voltage(25°C)		14.50 to 15.00V Temperature compensation: -30mV/°C
Maximum charging current		12A
Maximum discharge current		360A(5 sec.)
Designed floating life(20°C)		10 years

► Construction

Component	Positive plate	Negative plate	Container	Cover	Separator	Electrolyte	Safety valve	Terminal
Raw material	Lead dioxide	Lead	ABS	ABS	AGM	Sulfuric acid	Rubber	Copper

► Constant Current Discharge Characteristics Unit: A (25°C, 77°F)

F.V/Time	5min	10min	15min	30min	1HR	2HR	3HR	5HR	8HR	10HR	20HR
9.60V	120.6	78.4	59.7	38.5	22.8	13.3	9.7	6.8	4.5	4.0	2.1
9.90V	114.5	76.2	58.1	37.3	22.3	13.1	9.6	6.8	4.5	3.9	2.1
10.2V	110.2	74.5	57.3	36.4	21.9	13.0	9.5	6.7	4.4	3.8	2.0
10.5V	102.6	70.6	55.2	35.3	21.3	12.8	9.4	6.6	4.3	3.7	2.0
10.8V	94.5	66.3	53.4	34.3	20.8	12.6	9.3	6.5	4.2	3.6	1.9

► Constant Power Discharge Characteristics Unit: W (25°C, 77°F)

F.V/Time	5min	10min	15min	30min	1HR	2HR	3HR	5HR	8HR	10HR	20HR
9.60V	1233.7	830.0	654.9	423.3	259.9	152.5	111.4	78.2	52.3	43.9	23.3
9.90V	1169.5	805.8	640.7	412.5	254.2	151.7	110.6	77.6	52.1	43.6	23.1
10.2V	1127.0	788.7	629.2	405.5	249.4	150.3	110.2	76.9	51.8	43.4	22.9
10.5V	1087.9	766.0	613.5	395.0	243.2	149.1	110.0	76.2	51.5	43.2	22.8
10.8V	994.2	702.6	597.8	384.6	237.0	147.5	108.8	75.4	51.0	43.0	22.5

Note: The above characteristics data can be obtained within three charge or discharge cycles.

► Discharge Characteristics (25°C)

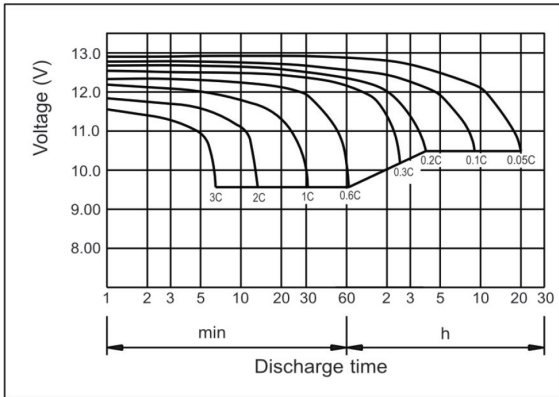

► Charging Characteristics (25°C)

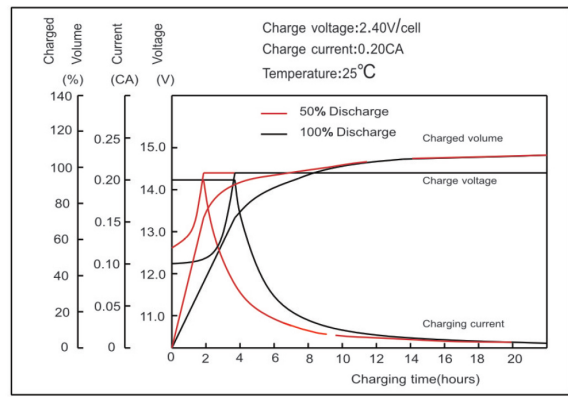

► Temperature effects on Capacity

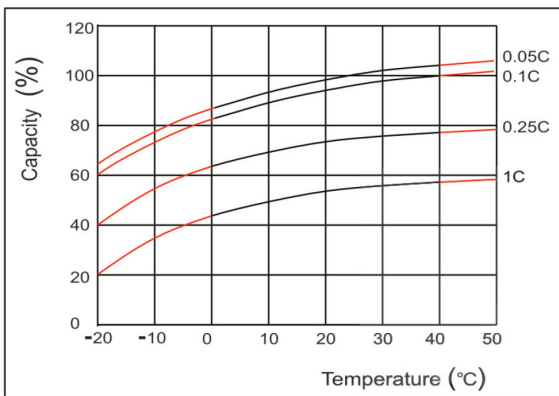

► Self-Discharge Characteristics

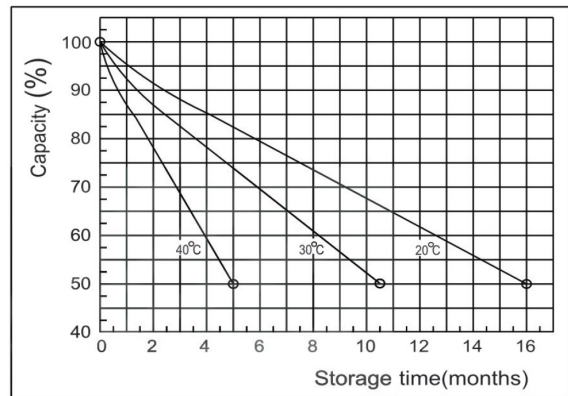

► Floating Life on Temperature

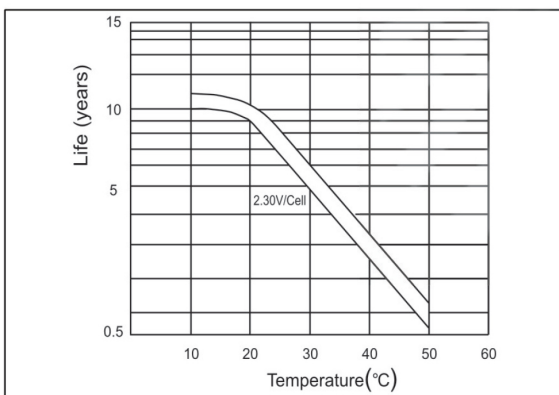

► Cycle Life on D.O.D (25°C)

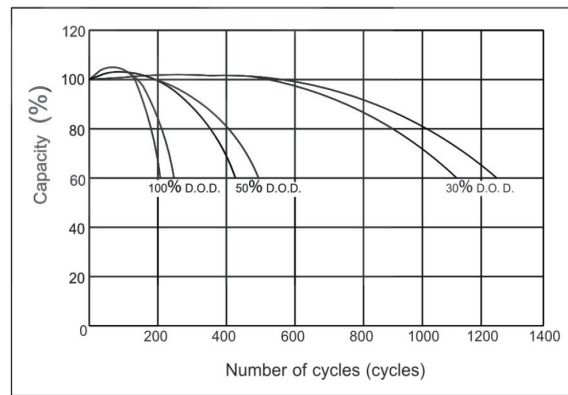

► The Relationship for OCV and Capacity (25°C)

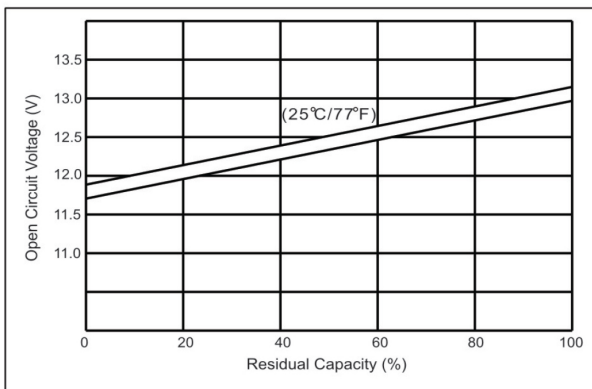

► The Relationship for Charging Voltage and Temperature

