

BLUE BATTERY

KESİNTİSİZ ENERJİ ÇÖZÜMLERİ

BL 12-200(GEL)



► Specifications

Nominal Voltage		12V
Rated capacity (10 hour rate)		200Ah
Dimensions	Length	522± 1.5mm(20.55inch)
	Width	239± 1mm (9.41inch)
	Height	217± 1mm(8.54inch)
	Total Height	222± 1mm(8.74inch)
Approx. Weight		60.2kg(132.72lbs)± 4%

► Outer Dimensions (mm)

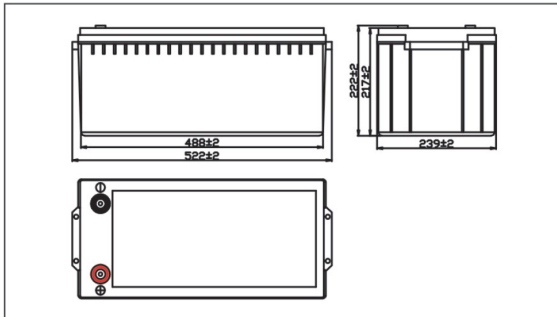

► Terminal Type (mm)

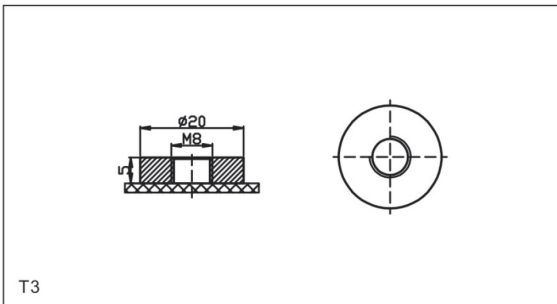

► Characteristics

Capacity (25°C)	20HR(10.5V)	210Ah
	10HR(10.5V)	200Ah
	1HR(9.60V)	123.4Ah
Terminal type		T3
Internal resistance (Fully charged, 25°C)		Approx. 3.4m Ω
Capacity affected by temperature (20HR)	40°C	102%
	25°C	100%
	0°C	85%
	-15°C	65%
Self-discharge (25°C)	3 months	Remaining Capacity: 91%
	6 months	Remaining Capacity: 82%
	12 months	Remaining Capacity: 65%
Nominal operating temperature		25°C± 3°C(77°F± 5°F)
Operating temperature range	Discharge	-15°C~50°C(5°F~122°F)
	Charge	-10°C~50°C(14°F~122°F)
	Storage	-20°C~50°C(-4°F~122°F)
Float charging voltage(25°C)		13.50 to 13.80V Temperature compensation: -18mV/°C
Cyclic charging voltage(25°C)		14.50 to 15.00V Temperature compensation: -30mV/°C
Maximum charging current		60A
Maximum discharge current		1800A(5 sec.)
Designed floating life(20°C)		12 years

► Construction

Component	Positive plate	Negative plate	Container	Cover	Separator	Electrolyte	Safety valve	Terminal
Raw material	Lead dioxide	Lead	ABS	ABS	AGM	Sulfuric acid	Rubber	Copper

► Constant Current Discharge Characteristics Unit: A (25°C, 77°F)

F.V/Time	15min	30min	60min	2h	3h	4h	5h	8h	10h	20h
9.60V	301.5	207.9	123.4	72.4	54.5	41.4	37.8	25.7	20.4	10.8
9.90V	293.6	203.2	121.2	71.8	53.6	41.1	37.2	25.3	20.3	10.7
10.2V	289.5	200.0	119.3	71.3	53.0	40.9	36.6	25.1	20.2	10.6
10.5V	276.5	195.0	115.2	70.7	52.6	40.6	36.3	24.6	20.1	10.5
10.8V	265.4	190.1	110.5	69.8	51.9	39.4	35.9	24.1	20.0	10.3

► Constant Power Discharge Characteristics Unit: W (25°C, 77°F)

F.V/Time	15min	30min	60min	2h	3h	4h	5h	8h	10h	20h
9.60V	3256.2	2332.4	1357.4	837.5	632.6	487.1	439.6	293.0	239.6	122.8
9.90V	3212.2	2256.5	1343.0	830.5	627.5	483.7	435.3	290.4	239.1	122.4
10.2V	3184.5	2239.4	1336.2	824.7	622.7	481.1	432.6	288.7	238.5	121.8
10.5V	3069.2	2187.9	1301.8	817.7	617.8	477.2	428.7	287.8	237.6	120.8
10.8V	2972.5	2127.5	1259.7	807.8	610.8	463.3	424.7	284.4	236.8	120.8

Note: The above characteristics data can be obtained within three charge or discharge cycles.

► Discharge Characteristics (25°C)

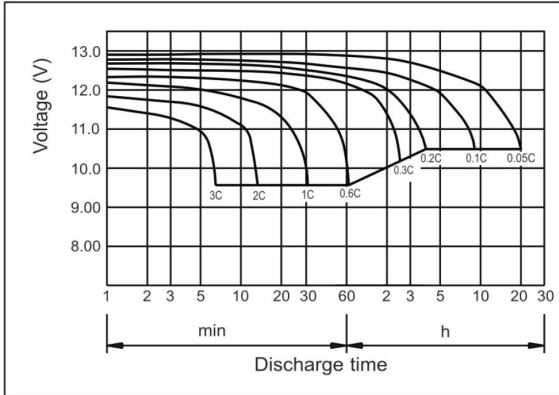

► Charging Characteristics (25°C)

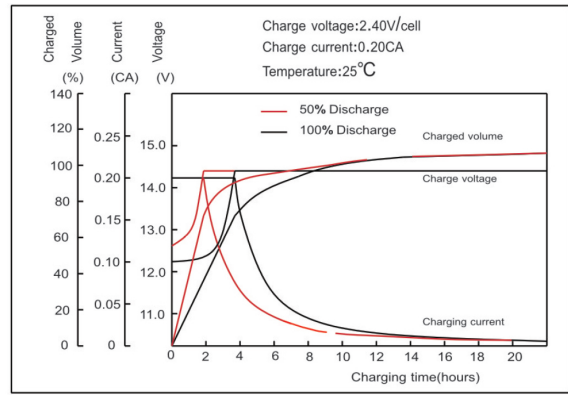

► Temperature effects on Capacity

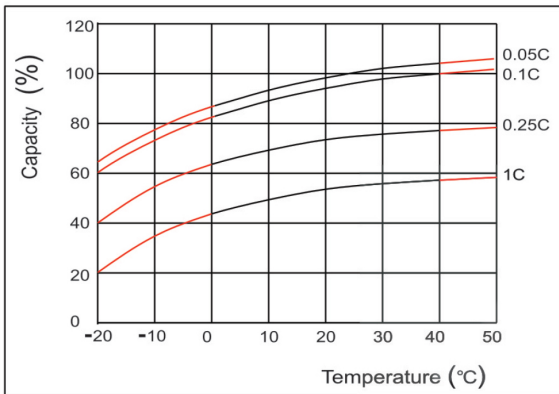

► Self-Discharge Characteristics

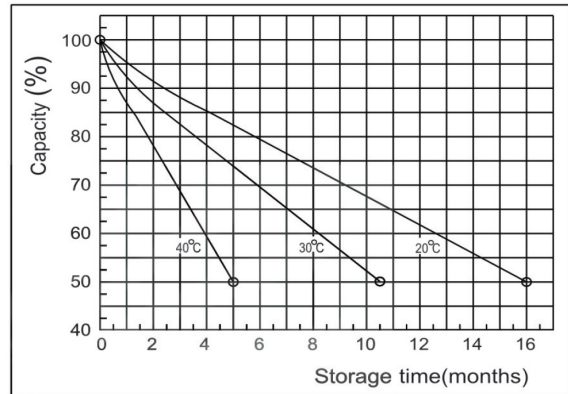

► Floating Life on Temperature

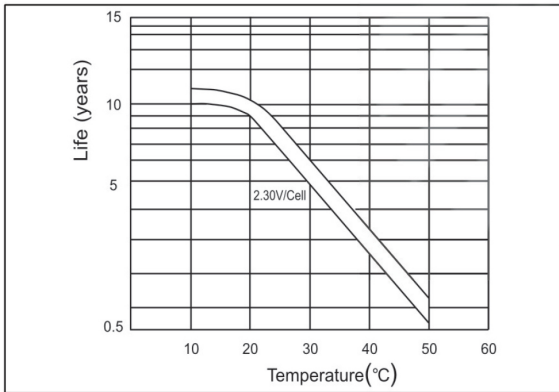

► Cycle Life on D.O.D (25°C)

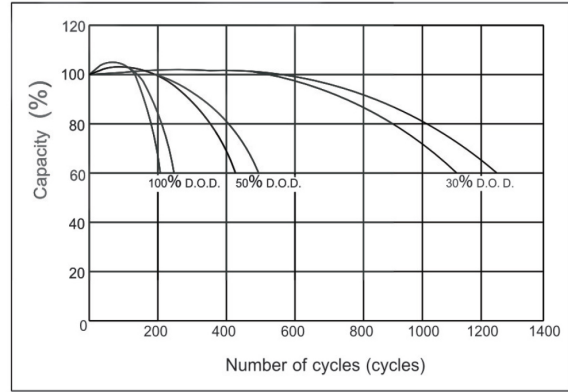

► The Relationship for OCV and Capacity (25°C)

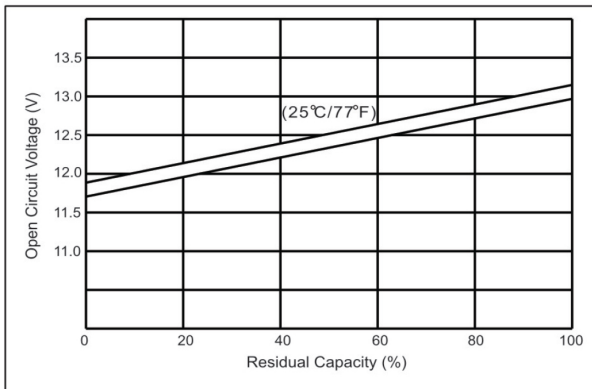

► The Relationship for Charging Voltage and Temperature

